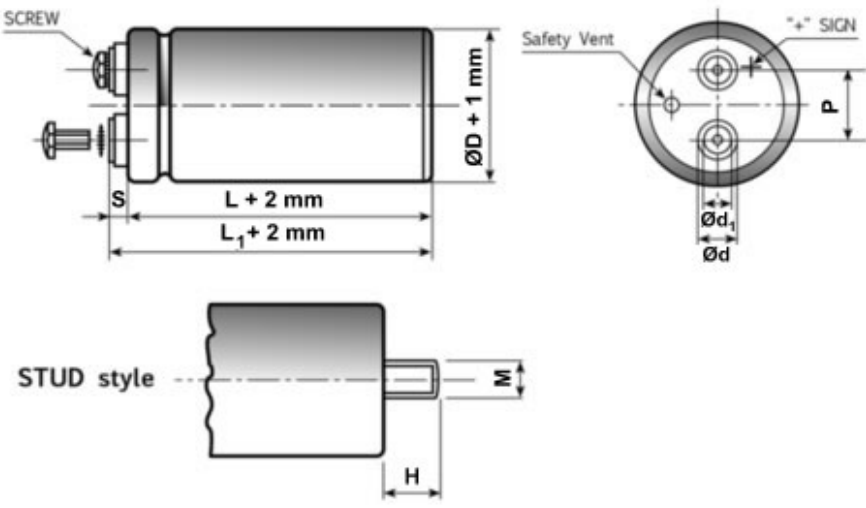



Diagram of dimensions (unit = mm)						76X143 (ØD x L)
ØD	d	P	M	H	SCREW	
35	11	12.7	M8	12	5MA x 9.5	
51	18.5	22.2	M12	16	5MA x 9.5	
63	18.5	28.6	M12	16	5MA x 9.5	
76	18.5 23.2	31.8 31.8	M12 M12	16	5MA x 9.5 6MA x 10	
90	23.2	31.8	M12	16	6MA x 10	
L1	L1 = L + 2.5mm L1 toll. -0+3mm		L1 = L + 4.5 mm L1 toll. -1 + 3 mm			
S	M5 = 5 -0+1mm from top of deck		M6 = 7 -1+1mm from top of deck			
<b>Marking</b>						
Type - Identification Code Lot						
Rated capacitance (µF), Rated voltage (Vdc)						
Negative polarity: gold row						
Product compliant RoHS Directive						

## ELECTRICAL PARAMETERS

Nominal Capacitance	6800	µF at 100 Hz
Tolerance Standard	M	= -20% +20% on request Q = -10% +30%
Temperature Range	.....	-40°C to 85°C
Rated Voltage / Surge Voltage	350/385	VDC
Max Tang δ	0.12	at 100 Hz
Typical ESR	16	mΩ at 100 Hz
Typical Impedance Z	15	mΩ at 10 kHz
Maximum Leakage Current	6.00	mA after 5 mins at 20°C
Maximum Ripple Current	19.20	A rsm at 85°C
Useful Life	> 12000	hours at 85°C for Vr<=100V and for Vr>=500V
Useful Life	> 15000	hours at 85°C for 100V < Vr < 500V
Reference Standards	CECC 30.300 IEC 384.4 Long Life Grade	

When ambient temperature and ripple frequency are different from 85°C and 100 Hz, ripple current shall be multiplied by the following compensating factor:

<b>FREQUENCY</b>	50 Hz	100 Hz	500 Hz	1000 Hz	> 10 kHz	<b>TEMPERATURE</b>	35°C	45°C	55°C	65°C	75°C	85°C	95°C
<b>FACTOR</b>	0.8	1.0	1.2	1.3	1.5	<b>FACTOR</b>	2.2	2.1	1.8	1.6	1.4	1.0	0.5